

DIN 6798 I

Serrated lock washers

Form I: internally toothed

Stainless steel A4 | Cr(VI)-free

Further information: Norm has been withdrawn without replacement

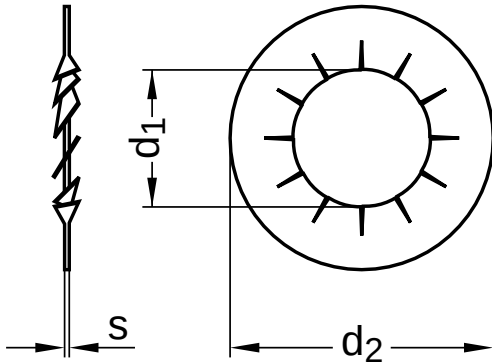

Diameter (d)	d ₁		d ₂		s nominal size
	min.	max.	min.	max.	
2.2	2.2	2.34	4.20	4.5	0.3
2.7	2.7	2.84	5.20	5.5	0.4
3.2	3.2	3.38	5.70	6.0	0.4
3.7	3.7	3.88	6.64	7.0	0.5
4.3	4.3	4.48	7.64	8.0	0.5
5.3	5.3	5.48	9.64	10.0	0.6
6.4	6.4	6.62	10.57	11.0	0.7
7.4	7.4	7.62	12.07	12.5	0.8
8.4	8.4	8.62	14.57	15.0	0.8
10.5	10.5	10.77	17.57	18.0	0.9
13	13.0	13.27	19.98	20.5	1.0
15	15.0	15.27	23.48	24.0	1.0
17	17.0	17.27	25.48	26.0	1.2
19	19.0	19.33	29.48	30.0	1.4
21	21.0	21.33	32.38	33.0	1.4
23	23.0	23.33	35.38	36.0	1.5
25	25.0	25.33	37.38	38.0	1.5
28	28.0	28.33	43.38	44.0	1.6
31	31.0	31.39	47.38	48.0	1.6

All technical data refer to the measure mm

